

 newbits



TUCANO 1

LAMPĂ SOLARĂ DE PERETE



INTRODUCERE

Specificațiile produsului

01 INTRODUCERE

02 CATALOG

03 AVANTAJE PRINCIPALE

04 SPECIFICAȚII

05 DIAGRAMA OPTICĂ

06 DIMENSIUNI

07 MAI MULTE DETALII

08 TEHNOLOGIA NUCLEU

09 DETALII PACHET

10 UTILIZARE

AVANTAJELE PRODUSULUI

Tehnologia ASL garanteaza 10 nopti de functionare continua
Tehnologia TCS asigura o durata de viata mare a bateriei

MAI LUMINOASE SI MAI DURABILE

Furnizeaza cea mai profesionala lumina solara de gradina pentru fiecare familie



SILVER



SILVER-GREY



BLACK



LUMINOZITATE: 1000 lm

Articol: SWL-05 PRO

Putere 10W

Panou solar

Putere

Policristalin, 0,6 W

Baterie Li-ion

Capacitate

3.7V 7.46WH 2AH/PC

Temp. de încărcare/descărcare

0~45°C/-20~60°C

Timp de incarcare

15H

LED (OSRAM)

2835 21 buc

Temp. culoare

3000KR_a 80+

Eficienta

190lm/W

LED UV

-

Performanta

Timp de iluminare în zilele ploioase

>10 zile

Modul de control

Buton comutator, ON/OFF Apăsare lungă 1,5 secunde

Modul de iluminare

M1: 0+PIR/1000LM(10S)

M2: 20LM+PIR/1000LM(10S)

Indicarea modului

-

Indicație de capacitate

-

PIR

120°3m

Tehnologia de bază

ALS 2.1 / TCS 1.0

Autocurățare panouri solare

-

Clasa IP/IK

IP65 / IK10

Înălțime de instalare

2,5 m-3 m

Diagrama simulată a drumului

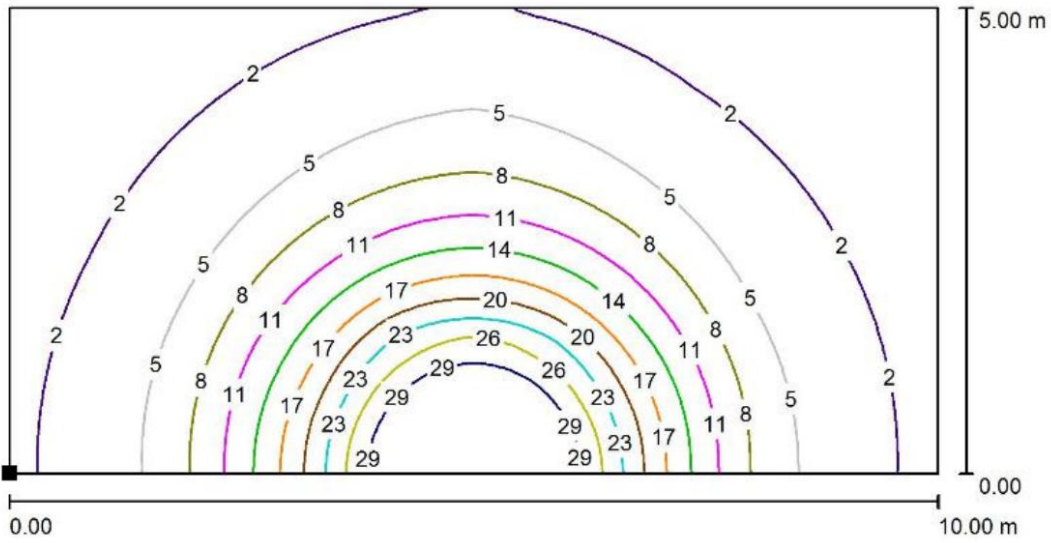

Curba de iluminare

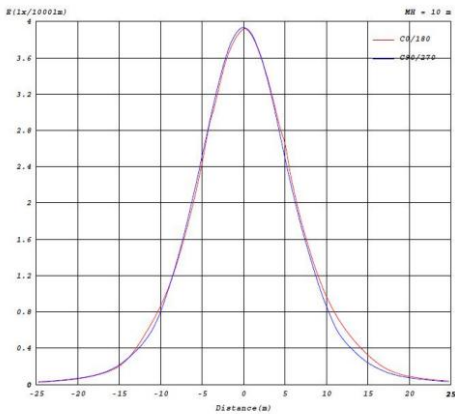

Distribuția Luminanței

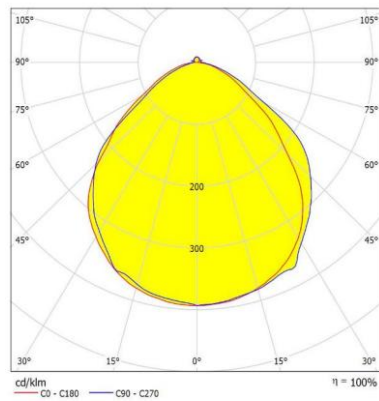

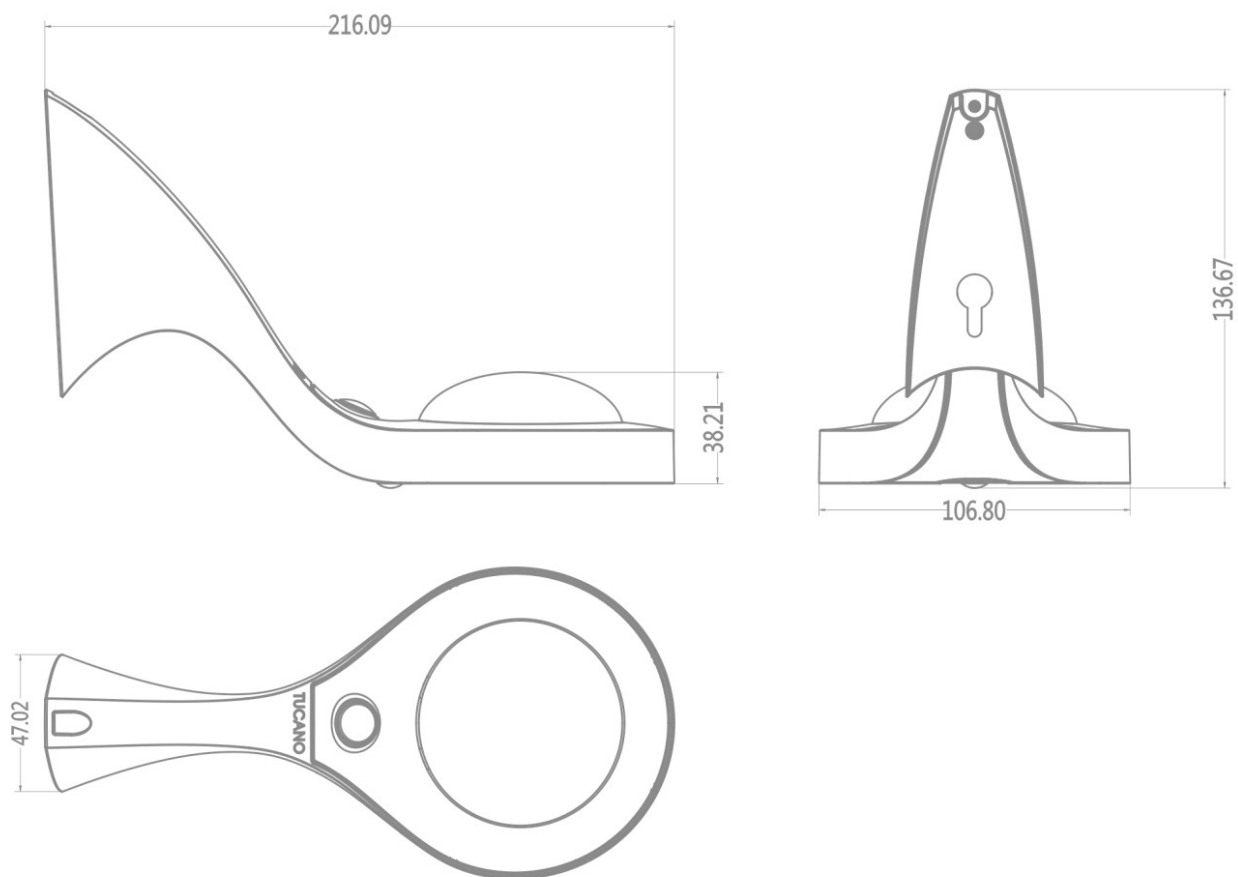

BENEFICII

- design din aliaj de aluminiu all-in one
- Distributie stiintifica a luminii
- Inductia corpului uman
- Inductie de control al iluminarii
- Cip LED OSRAM

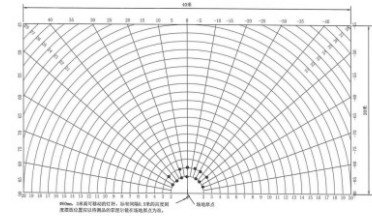

Policristalina
Eficienta de încarcare solara:> 19%



LED-uri cu lumen mare 190lm/W
PIR:>3m,120°



Imagine din spate



O companie mare ar trebui sa acorde intotdeauna o atentie ridicata la designul fiecarui detaliu, iar spiritul de maiestrie, ar trebui completat in procesul de proiectare si productie in masa.

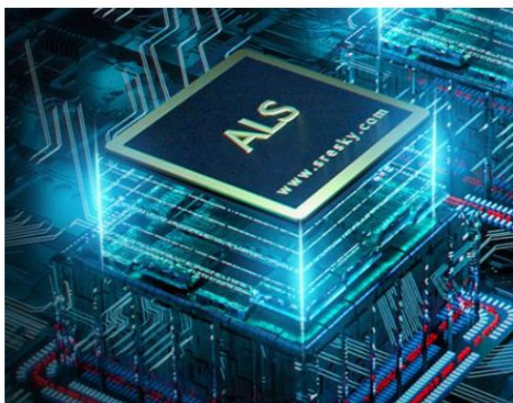

AVANTAJUL ALS

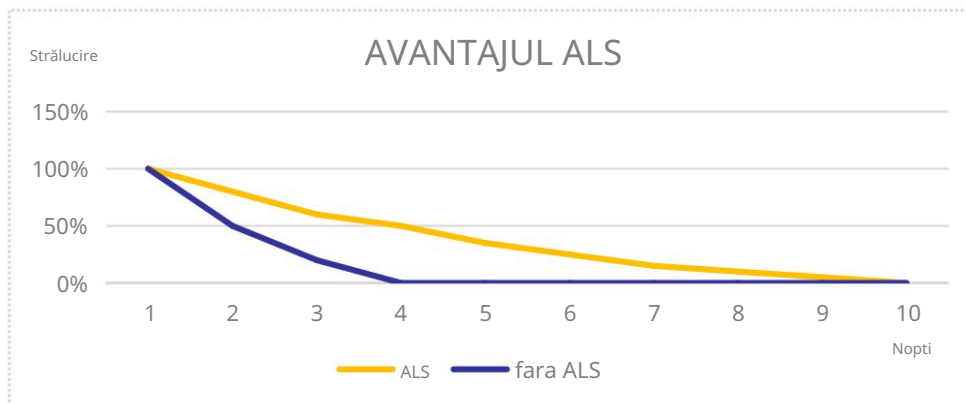

AVANTAJUL TCS

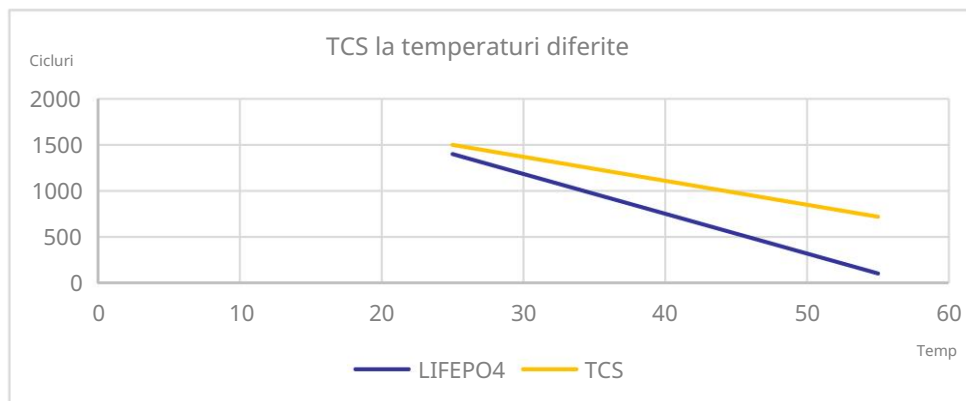

LISTA DE PRODUSE

Șurub: 2 buc
Șuruburi cu expansiune: 2 buc

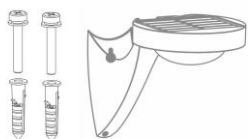

CUTIE INTERIOARĂ
DIMENSIUNE: 11,5*11,5*27,0 cm
2 BUC. / 1 CUTIE



1 STRAT
1 STRAT = 12 CUTII
12 CUTII = 24 BUC

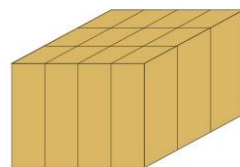

MASTER CARTON
DIMENSIUNE: 48.0*36.3*29.0cm
12 CUTII / CTN
24 BUC / CTN

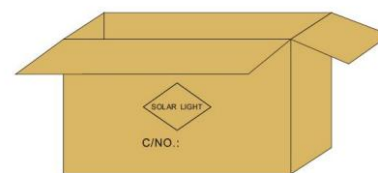

CUTIE DE CARTON

NUMĂRUL STRATULUI

CUTIE COLOR

LISTA DE PRODUSE

PASUL 1

PASUL 2

PASUL 3

PASUL 4

NUMARUL MODELULUI	METODA DE AMBALARE	PCS/CTN	CANTITATE (BUC)	CTN CANTITATE	DIMENSIUNE CARTON (MM)	NW (KG)	GW (KG)
SWL-05 PRO	CUTIE INTERIOARA	2	2	1	11,5*11,5*27,0	0,54	0,66
	CUTIE DE CARTON	24	24	1	48,0*36,3*29,0	7.9	8.7

Greutatea netă și greutatea brută sunt doar pentru referință

S / O / L / A / R / L / I / G / H / T

VA MULTUMIM!

